



Freude am Fahren

BMW Wallbox Plus

Installation instructions



BMW Wallbox Plus
Installation instructions

5

EN

BMW Wallbox Plus

Installation instructions

Contents

INFORMATION	10
Safety information	10
Intended use	12
About this manual	12
Package	13
Warranty	13
OPERATION	14
Displays and controls	14
SPECIFICATIONS	16
General criteria for selecting an installation site	16
Specifications for the electrical connection	18
Electrical connection for special types of networks	18
INTEGRATION OF EXTERNAL METERS	20
Domestic connection monitoring (post-meter fuse)	20
Installation of the external meters	21
INSTALLATION	23
Installation requirements	23
Recommended installation positions	24
Required distance	25
Removing the housing cover	26
Removing the termination panel cover	27
Removing the terminal cover	28
Surface-mounted cable routing – cable inlet from above	28
Surface-mounted cable routing – cable inlet from below	29
Cable inlet from behind – cable in the wall	29
Cable openings	30
Installing the Wallbox	31
ELECTRICS	35
Connection diagram with open termination panel cover	35
Connecting the supply cable	36

Using the supply terminals (spring-type terminal)	37
Terminals X1/X2	38
Enable input X1	39
RS485 connection X2	40
Ethernet1 connection X4	41
SETTINGS	43
DIP switch settings	43
COMMISSIONING	48
General commissioning procedure	48
Commissioning mode/Self-test	48
Safety tests	49
RFID authorisation	49
Installing the terminal cover	50
Installing the termination panel cover	51
Installing the housing cover	52
MISCELLANEOUS	53
Dimensions	53
Technical data	54
MAINTENANCE	57
Replacing the fuse	57
DISPOSAL	58
SOFTWARE UPDATE	59
PRODUCT INFORMATION PAGE	60
INDEX	61

Legal information

Bayerische Motorenwerke Aktiengesellschaft
Munich, Germany

www.bmw.com

Translation of the original installation instructions

Copyright ©2020 BMW AG Munich

This documentation contains information protected by copyright. All rights reserved, especially the right of reproduction and distribution. No part of this documentation may be reproduced (photocopying, scanning or any other procedures) or processed, copied or distributed in any form using electronic systems without the written consent of Bayerische Motorenwerke Aktiengesellschaft.

Contraventions are liable to compensation.

About this manual

Keep this manual for the full service life of the product.

Read these instructions carefully and look at the device to familiarise yourself with it before you attempt to install, operate or service it. The following special information may be displayed in this documentation or on the device to warn you of possible dangers or point to information which explains or simplifies a process.

Use the operating manual to operate the Wallbox and to obtain explanations of errors on it.

Keep this manual safe for later use. The latest manuals can be downloaded from the Internet at <https://charging.bmwgroup.com/web/wbdoc/>.

Symbols used

You will find information and warnings about possible dangers at various points in the manual. The symbols used in the manual mean the following:



WARNING

Means that death or serious physical injury may occur if the appropriate precautions are not taken. ◀



CAUTION

Means that property damage or minor physical injury may occur if the appropriate precautions are not taken. ◀



IMPORTANT

Means that property damage may occur if the appropriate precautions are not taken. ◀



ESD

This warning points out the possible consequences of touching electrostatically sensitive components. ◀



Note

Indicates procedures which do not involve any danger of injury. ◀



This lightning symbol means a danger of electric shock.

Access for trained, authorised electricians only.

Information on equipment and functions

This manual contains a list of all the systems and functions that are currently available. It therefore also describes systems and functions which may not be available to you as a result of the device version or the specific installation and configuration of your device. In rare instances this may also mean that there are differences between the description and your device.



Note

Your BMW dealer will be delighted to help find a qualified installation contractor. ◀

INFORMATION

Safety information

Read the safety information carefully and look at the device to familiarise yourself with it before you attempt to install, operate or service it.



WARNING

▷ Electrical danger!

The Wallbox must be installed, commissioned and serviced by appropriately trained, qualified and authorised electricians⁽¹⁾ who bear full responsibility for compliance with current standards and installation regulations.

Please note that an additional overvoltage protector may be required by vehicles or national regulations.

Please refer to your national connection and installation standards.

- ▷ Only connect voltages and circuits to the right-hand connection area (Ethernet, terminals for control cables) which can be safely isolated from dangerous voltages (for example through adequate insulation).
- ▷ Before commissioning the device check that all screw and terminal connections are tight.
- ▷ The terminal panel must never be left open without supervision. Fit the terminal panel cover when you leave the Wallbox.
- ▷ Do not make any unauthorised changes or modifications to the Wallbox.
- ▷ Repair work to the Wallbox is not permitted and may only be completed by the manufacturer or a trained expert (Wallbox replacement).
- ▷ Do not remove any identifiers such as safety symbols, warning instructions, rating plates, labels or cable markings.
- ▷ The Wallbox does not have its own mains switch. The residual-current-operated circuit breaker and circuit breaker on the building insulation is used as a mains isolation device.
- ▷ Pull the charging cable out of the connector by the plug, not the cable.
- ▷ Ensure that the charging cable is not mechanically damaged (kinked, jammed or run over) and that the contact area does not come into contact with heat sources, dirt or water.
- ▷ Do not put your fingers into the connector.
- ▷ Always conduct a visual inspection for signs of damage before charging. Pay particular attention to dirt and moisture on the charging plug, cuts on the charging cable or chafing on the insulation, and also ensure that the cable output from the Wallbox is securely fastened. ◀

⁽¹⁾ People who, as a result of the training, skills and experience and knowledge of the relevant standards can assess the work and identify possible dangers.



IMPORTANT

- ▷ Never clean the Wallbox using a jet of water (hosepipe, pressure washer, etc.)!
- ▷ Ensure that the Wallbox is not damaged by incorrect handling (housing cover, internal parts, etc.).
- ▷ If it is raining or snowing and the Wallbox is installed outdoors, do not open the terminal panel cover.
- ▷ Danger of breaking the plastic housing.
 - Do not use countersunk screws to secure the device.
 - Do not tighten the securing screws with force.
 - The installation the area must be completely flat (max. 1 mm difference between the support and securing points). Do not bend the housing. ◀



Information for trained personnel who may open the device:

Danger of damage. Electronic components may be destroyed if touched.

Before handling modules, perform an electrical discharge process by touching a metallic earthed object. ◀

A failure to follow the safety information may result in a danger of death, injury and damage to the device. The device manufacturer cannot accept any liability for claims resulting from this.

Intended use

The Wallbox is a charging station for indoor and outdoor use for charging electric or plug-in hybrid vehicles. Do not connect any other devices such as electric tools. The Wallbox is designed for installation on a wall or a column. Comply with the relevant national regulations for installing and connecting the Wallbox.

The intended use of the device in every case includes compliance with the ambient conditions for which this device was developed.

The Wallbox was developed, manufactured, tested and documented on the basis of the relevant safety standards. If you comply with the instructions and safety information described for its intended use, the product normally will not pose any danger in terms of property damage or to the health of people.

This device must be earthed. In the event of an error, the earth connection will reduce the danger of an electric shock.

The instructions contained in this manual must be followed to the letter. Otherwise sources of danger may be created or safety equipment may be rendered inoperable. In addition to the safety information provided in this manual, the safety and accident prevention regulations relating to the specific device must be followed.

Not all versions/options are available in all countries as a result of technical or statutory restrictions.

About this manual

This manual and the functions described in it are valid for devices of the following type:

- ▷ BMW Wallbox Plus

This manual is designed exclusively for trained personnel. These are people who, as a result of their training, skills and experience and their knowledge of the relevant standards, can assess the work assigned to them and identify possible dangers.

The illustrations and explanations contained in this manual refer to a typical version of the device. Your device version may differ from this.

Please refer to the operating manual for information and instructions for operating the device.

Package

Description	Quantity
Wallbox	1 x
Installation instructions	1 x
Operating instructions	1 x
Drilling template	1 x
RFID card	4 x
Label with configuration information, to be kept safely	1 x
Double membrane seal M32 or ¾" NPT (clamping area 14–21 mm)	1 x
Double membrane seal M16 (clamping area 7–12 mm)	2 x
Fastening set for wall mounting	
Dowels for M8, Fischer UXR-10	4 x
Wafer-head screw	4 x

Warranty

BMW Service can provide more information on the terms of the warranty. However, the following cases are not covered by the warranty.

- ▷ Defects or damage caused by installation work which was not carried out as specified in the BMW Wallbox Plus installation instructions.
- ▷ Defects or damaged cause by the product not being used as specified in the BMW Wallbox Plus operating instructions.
- ▷ Costs and damage caused by repair work not carried out by a specialist electrician authorised by a BMW sales outlet or authorised service workshop.

OPERATION

Displays and controls

BMW Wallbox Plus – variant with charging cable

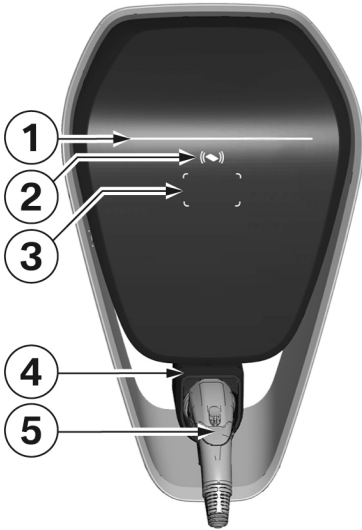

Functions:

- ▷ Charging electric or plug-in hybrid vehicles
- ▷ Network connection using LAN
- ▷ Local smartphone app
- ▷ RFID functionality
- ▷ Domestic connection monitoring (post-meter fuse) using a directly connected Modbus RTU (RS485) electricity meter

1 Status LED

2 RFID status indicator

3 RFID reading area

4 Charging cable plug holder

5 Charging cable plug

BMW Wallbox Plus – Version with charging socket



The version with a charging socket has the same functions as the version with a charging cable.

The Wallbox is fitted with a charging socket including shutter (additional contact protection) to suit the national regulations of the country in which it is installed.

1 Charging socket with shutter

2 Charging cable plug holder



Note

No charging cable is included; a separate charging cable is required. ◀

SPECIFICATIONS

General criteria for selecting an installation site

The Wallbox has been designed for indoor and outdoor use. It is therefore necessary to ensure the correct installation conditions and protection for the device at the installation site.

- ▷ Take into account the local electrical installation regulations, fire prevention regulations and accident prevention regulations as well as the rescue routes at the site.
- ▷ Do not install the Wallbox at locations:
 - ▷ Which are used as escape and rescue routes.
 - ▷ Which are inside potentially explosive zones (EX environment).
 - ▷ At which the Wallbox is exposed to ammonia or ammonia gases (for example in or near stables).
 - ▷ At which the Wallbox may be damaged by falling objects (for example suspended ladders or car tyres).
 - ▷ At which the Wallbox is on a direct personnel route and people could stumble over the connected charging cable.
 - ▷ At which the Wallbox may be struck by jets of water (for example due to neighbouring manual car wash systems, pressure washers or garden hoses).
 - ▷ At which the installation surface does not have sufficient strength to withstand the mechanical stresses.
- ▷ If possible install the Wallbox so that it is protected from direct rainfall so as to avoid the effects of weather, icing, damage by hailstones or the like.
- ▷ If possible install the Wallbox so that it is protected from direct sunlight to prevent the charging current being reduced or the charging process being interrupted as a result of excessive temperatures on components of the Wallbox.
- ▷ Comply with the permitted ambient conditions, see section entitled [Technical data](#).
- ▷ Ensure compliance with national and international installation standards and regulations, for example IEC 60364-1 and IEC 60364-5-52.
- ▷ Ensure compliance with national regulations (for example the charging column regulation in Germany) for the implementation of the EU Directive (2014/94/EU) relating to the binding minimum technical specifications for sockets and vehicle couplings for charging electric or plug-in hybrid vehicles in areas accessible to the public. This regulation relates to charging points on public land as well as department store or customer car parks, for example. Charging points on private carports or private garage entrances are not generally publicly accessible charging points in terms of this regulation.



Note

If the device is installed in a location where it is not protected from the weather, for example in an outdoor car park, the charging current will be reduced to 16 A if the temperature exceeds the limit value. ◀

Specifications for the electrical connection

When it is delivered, the Wallbox is set to 10 A.

Ensure that you set the maximum current to suit the installed circuit breaker using the DIP switches, see section entitled [DIP switch settings](#).

Selecting the residual-current-operated circuit breaker

The supply cable must be permanently wired into the existing building installation and comply with the national statutory regulations.

- ▷ Each Wallbox must be connected using a separate residual-current-operated circuit breaker. No other circuits may be connected to this residual-current-operated circuit breaker.
- ▷ RCCB at least Type A (30 mA trip current).
Additional action has been taken in the device to provide protection in the event of DC fault current (>6 mA DC). In addition, the specifications of the vehicle manufacturer must be observed.
- ▷ The rated current I_N must be selected to suit the circuit breaker and the back-up fuse.

Selecting the circuit breaker

When selecting the circuit breaker, also take the increased ambient temperatures in the control cabinet into consideration. In certain circumstances this may require a reduction in the charging current to increase the system availability.

Set the rated current to suit the model plate details in conjunction with the required charge rating (DIP switch settings for the charging current) and the supply cable.

Selecting the supply cable

When selecting the supply cable, take into account the possible reduction factors and the increased ambient temperatures in the internal connection area of the Wallbox, see the temperature rating of the supply terminals. In certain circumstances this may require an increase in the cable cross-section and an adjustment in the temperature resistance of the supply cable.

Mains isolation device

The Wallbox does not have its own mains switch. The residual-current-operated circuit breaker and/or the circuit breaker in the supply cable are used as a mains isolation device.

Electrical connection for special types of networks

The Wallbox is fundamentally compatible with various types of networks (TN, TT or IT systems).

It is recommended to connect the Wallbox only as a single-phase in networks with a delta connection without an upstream transformer. A three-phase connection in networks with a delta connection should only be implemented with an upstream transformer ("delta-star converter").

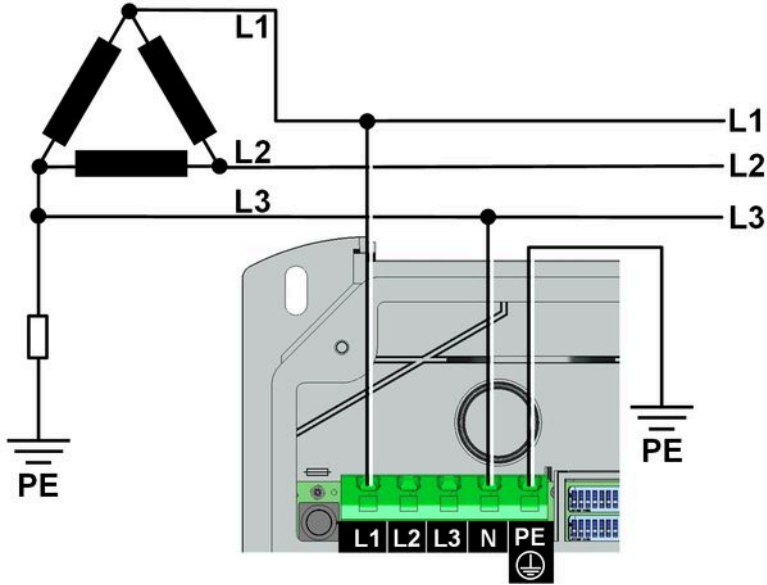

Connection to a three-wire IT system

INTEGRATION OF EXTERNAL METERS

To enhance the functionality of your Wallbox, it is possible to extend it with external meters.

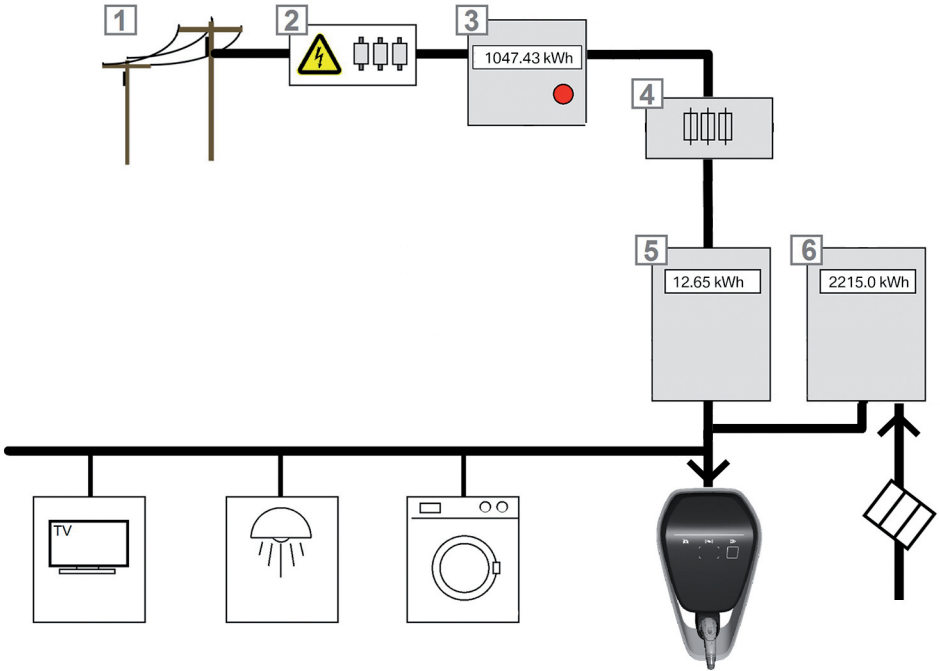

1 Public mains supply

2 Pre-meter fuse (reinforced fuse, SLS switch, etc.)

3 Mains operator's electricity meter

4 Post-meter fuse

5 Meter 1 (optional, domestic connection meter)

6 Meter 2 (optional, photovoltaic meter)



Note

This sample circuit diagram provides a system overview and does not contain all the additional equipment required for operating the system safely (circuit breakers, RCCB, etc.). The PV power supply may also take a different form. ◀

Domestic connection monitoring (post-meter fuse)

The domestic connection monitoring function charges the car dynamically at any time using the available charging current depending on the other consumers on the domestic connection. This ensures that the domestic connection fuse is not overloaded and a lower charging capacity than possible for the car and the installation does not generally have to be selected.

The Wallbox receives all its current power from the power supply through meter **5**. This information in combination with the value for the post-meter fuse **4** defined using the DIP switches enables the Wallbox to control the charging current such that the maximum power consumption never exceeds the post-meter fuse value.

Installation of the external meters

The meters can be connected to the Wallbox Plus via RS485 (Modbus).

The installed meters must be connected with the same phase sequence as the Wallbox so that the domestic load calculation can be performed correctly. If the Wallbox has to be connected starting with phase 2 to ensure better division of the phase loads, the meters must also be connected starting with phase 2.



Note

Detailed information on the meter installation is available in the installation instructions provided by the meter manufacturer. ◀



Note

The meter values may undergo a plausibility check after connection using the Wallbox web interface. Information on the Wallbox web interface is provided in the operating manual for the BMW Wallbox in the section headed "Configuration". ◀

Meters with Modbus RTU (RS485) interface

Using this interface it is possible to operate multiple meters from different manufacturers on a single bus. A separate cable is required from the Wallbox to the domestic insulation for connection. The advantage compared to network-capable Modbus TCP meters is the fact that it is not dependent on additional infrastructure such as routers. This ensures high operational reliability if the cabling is correct.

A detailed description of the connection of Modbus RTU meters via RS485 is provided in the section entitled [RS485 connection X2](#).



Note

The maximum fuse value must be set using the DIP switches in the connection area of the Wallbox, see section entitled [DIP switch settings](#). ◀

The current list of supported meters can be found on the BMW Service page for charging products at <https://charging.bmwgroup.com/web/wbdoc/>.

DIP switch settings

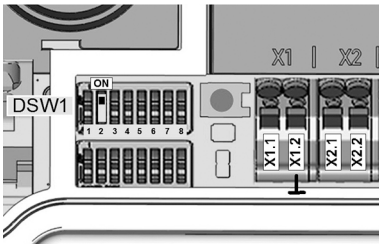

The use of the domestic connection monitoring function with RS485 meters must be selected using a DIP switch setting and does not come into effect until the Wallbox has been restarted. If no meter **5** is found when the ModBus function has been enabled, the charging current is reduced to 10 A.

- ▷ No monitoring: DSW1.2 = **OFF** (default)
- ▷ Monitoring function: DSW1.2 = **ON**

This reduction is also visualised on the Wallbox status LED. Further information is provided in the Wallbox operating manual.

INSTALLATION



Note

The maximum charging current of the Wallbox on delivery is set to 10 A. ◀

Installation requirements

- ▷ Follow the local installation regulations.
- ▷ The electrical connection (supply cable) must be prepared.
- ▷ Acclimatisation: If there is a temperature difference of more than 15 °C between transport and the installation site, the Wallbox must be acclimatised unopened for at least two hours.

Opening the Wallbox immediately may result in condensation formation in the interior and cause damage when the device is switched on. In certain circumstances, damage caused by condensation formation may also not appear until a later date after the installation.

Ideally, the Wallbox should be stored for a few hours in advance at the installation site. If this is not possible, the Wallbox should not be stored in low temperatures (< 5 °C) overnight outdoors or in a vehicle.

Tool list

The following tools will be required for the installation work:

- ▷ Slotted screwdriver for supply terminals, blade width 5.5 mm
- ▷ Slotted screwdriver for terminals X1/X2, blade width 3.0 mm
- ▷ Phillips screwdriver PH2
- ▷ LSA+ insertion tool for connecting the mains cable
- ▷ Torx screwdriver T40

Recommended installation positions

When selecting the installation position, taken note of the position of the charge connector on your vehicle and the direction in which you normally park it. Examples:

BMW i3

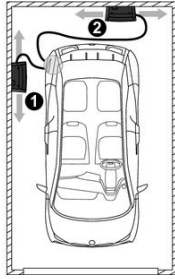
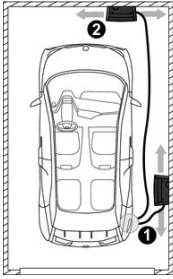

BMW/MINI PHEV

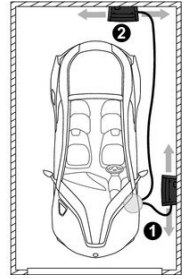
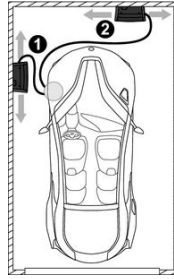

1 Recommended installation position

2 Alternative installation position

Required distance

The distance shown below (hatched area) will ensure easy installation and operation of the Wallbox. If several Wallboxes are installed next to each other, a distance of at least 200 mm (8") must be left between them.



Note

The installation height must be complied with to meet the requirements for both indoor and outdoor use. ◀

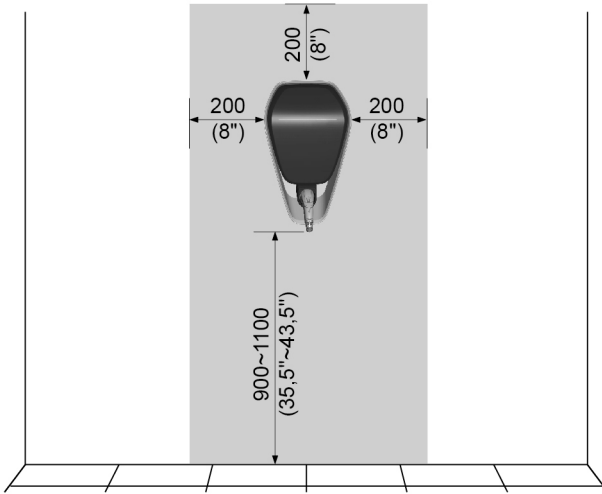

Dimensions in millimetres (inches)

Removing the housing cover

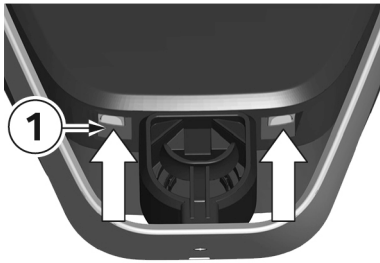

1. Press the two interlocks **1** for the housing cover on the underside of the Wallbox upwards.

The housing cover should then jump out slightly at the bottom.

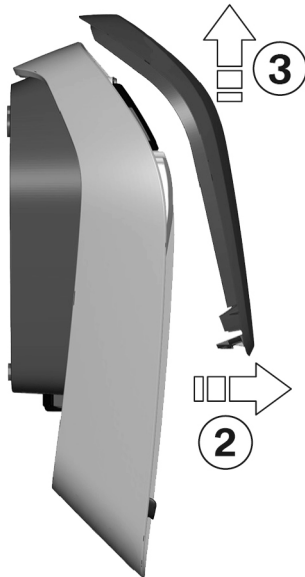

2. Swing the housing cover forwards a little on the underside **2**.

3. Then release the housing cover by raising it **3**.



Note

Keep the housing cover in the packaging to prevent it being scratched or suffering other damage. ◀

Removing the termination panel cover

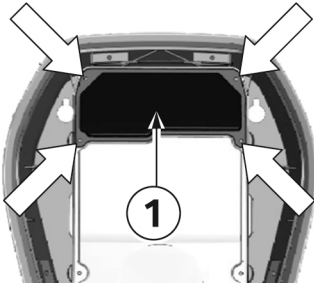

1. Undo the four screws used to secure the termination panel cover **1**.



ESD

Danger of damage. Electronic components may be destroyed if touched.

Before handling modules, perform an electrical discharge process by touching a metallic earthed object. ◀

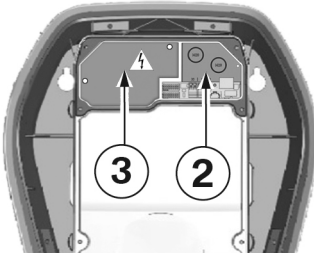

2. Remove the termination panel cover. The termination panel **2** is now accessible.
3. Remove the silica bag from the terminal panel and dispose of it properly.



WARNING

The cover over the connection area **3** for the mains voltage may only be removed by a qualified electrician. ◀

Removing the terminal cover



WARNING

Electrical danger. The terminal cover may be opened only by authorised electricians with the appropriate training and qualifications. ◀

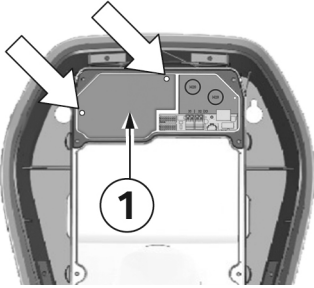

1. Undo the two fastening screws on the terminal cover **1**.
2. Remove the terminal cover over the supply terminals.

Surface-mounted cable routing – cable inlet from above

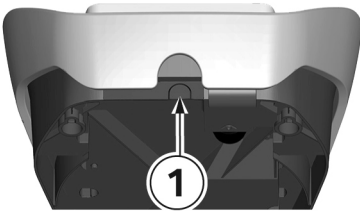

The connection cables may be inserted from above through the opening in the housing in the external frame.

1. Break off the marked point **1** on the internal housing section for this purpose.
2. Route the supply cable in a loop to the cable gland **2**.
Comply with the maximum bending radii of the cable.

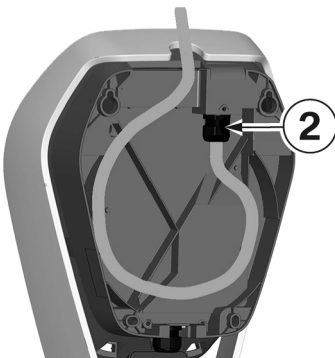

Surface-mounted cable routing – cable inlet from below

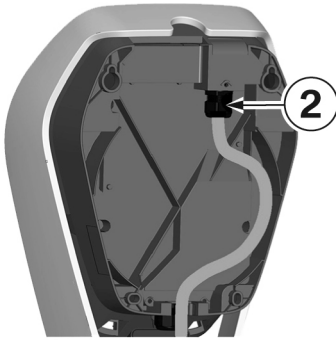

1. Route the supply cable in a loop to the cable gland **2**.
Comply with the maximum bending radii of the cable.

Cable inlet from behind – cable in the wall



Note

The cable is to be inserted straight out of the wall into the rear of the device. Ensure that the Wallbox is correctly positioned so that the cable opening is directly above the cable. Ensure that you comply with the minimum bending radii. Use the drilling template with the appropriate punching for the cable to ensure the correct alignment of the Wallbox above the wall outlet. ◀

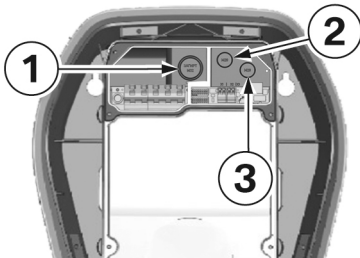

Cable openings

1 Bushing/Double membrane seal M32, supply cable

2 and **3** Bushing/Double membrane seal M16, for control cable/Ethernet

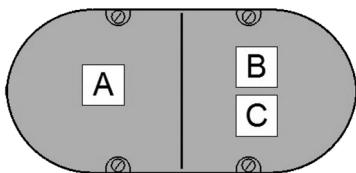

Flush-mounted socket

A double flush-mounted socket with a separating web may be used for safe separation.

A Supply cable

B Control cable

C Ethernet

Cable openings

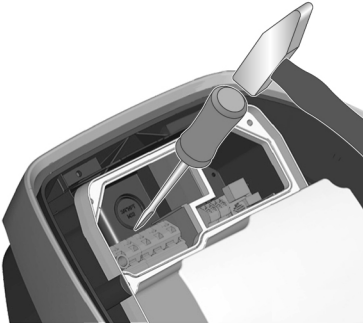

Break off cable openings

1. Place the housing on a stable surface.
2. Carefully remove the required cable openings using a hammer and slot head screwdriver.
3. Then insert the appropriate bushings, cable glands or double membrane seals.
4. Fit the Wallbox with the supplied cable glands or blind glands if a cable opening is no longer to be used.

Installing the Wallbox

The supplied fastening material is suitable for concrete, brick and wood (without wall plugs). A suitable fastening method must be selected for other surfaces.



Note

The fastening materials must be provided by the customer for different surfaces. Correct installation is essential and is not the responsibility of the device manufacturer. ◀

Preparations for installation

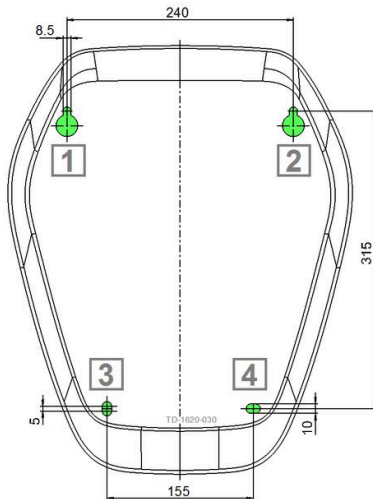

Boreholes



Note

Ensure that you comply with the installation height.

Top of the drilling template =
1500 - 1700 mm. ◀

1. Mark the four boreholes **1** to **4** using the supplied drilling template and a spirit level.
2. Drill the fastening holes.
3. Insert the wall plugs.

Top fastening screws

1. Screw in the two top wafer-head screws until they are ≥ 20 mm from the wall.

- 1** Wall
- 2** Wall plug
- 3** Borehole
- 4** Wafer-head screw

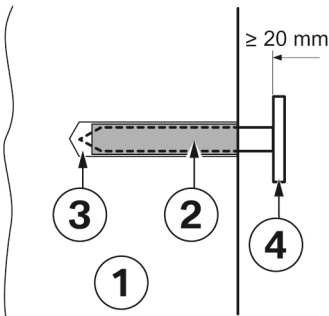

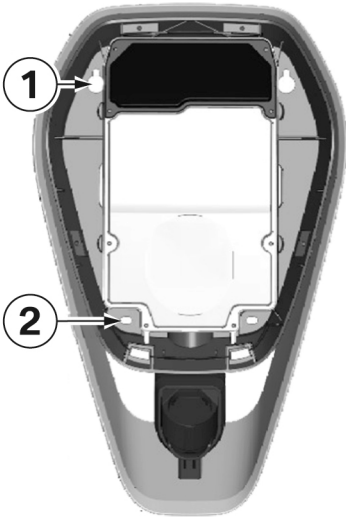

Installation on cavity walls

For installation on cavity walls, at least two fastening screws, for example **1** and **2**, must be fastened to a solid element in the wall.

Special cavity wall plugs must be used for the other fastening screws.



Note

For installation on cavity walls, it must be ensured that the structure has an adequate load-bearing capacity. ◀

Inserting the supply cable

General information

- ▷ Use a suitable cable sheath diameter on the supply cable or increase the cable sheath diameter using suitable sealing adapters.
- ▷ Insert the supply cable a sufficient way into the cable gland or double membrane seal. The cable sheath must be visible in the connection zone.
- ▷ The installation duct or empty ductwork with the supply cable must not be screwed into the cable gland or fed through the double membrane seal.
- ▷ The supply cable must be routed in a straight line not exceeding the bending radii (approximate cable diameter times 10) through the cable gland or double membrane seal.
- ▷ The cable gland or double membrane seal must be installed correctly and adequately secured.

Cable routing from above/below

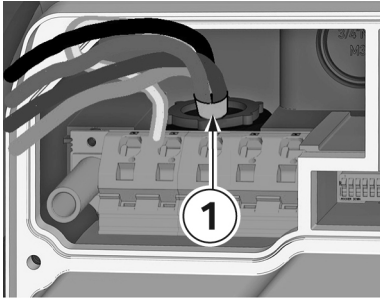

1. Route the supply cable through the cable gland and tighten the gland.

The cable sheath **1** must be visible in the connection zone.

Cable routing from behind (in wall)

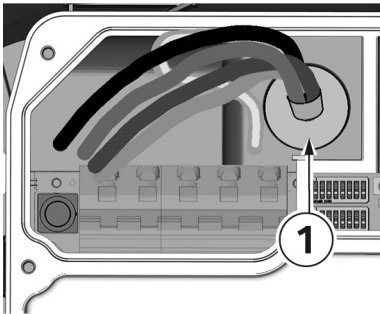

1. The supply cable must be routed through the bushing/double membrane seal **1** as shown in the illustration.



IMPORTANT

- ▷ Ensure that the double membrane seal sits cleanly on the cable sheath.
- ▷ Ensure that the supply cable is routed through the double membrane seal centrally, straight and without pressure so that the seal is tight. ◀

Inserting additional cables

1. Run the required additional cables, such as the bus cable for external electricity meters or Ethernet, into the connection zone of the Wallbox.
2. Use the supplied double membrane seal M16 to seal the bushing.

Securing the Wallbox

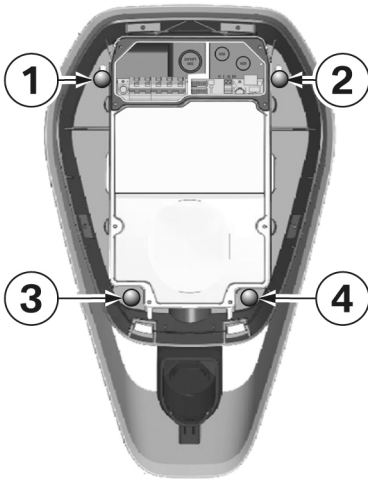

1. After inserting the cable, attach the Wallbox to the two top wafer-head screws **1** and **2**.



Note

Ensure that the supply cable is correctly routed to the rear and is not jammed. ◀

2. Tighten the wafer-head screws **1** and **2**.
3. Then secure the Wallbox with the two bottom wafer-head screws **3** and **4**.
4. Coil the charging cable around the Wallbox for safekeeping, see operating manual.

ELECTRICS

Connection diagram with open termination panel cover

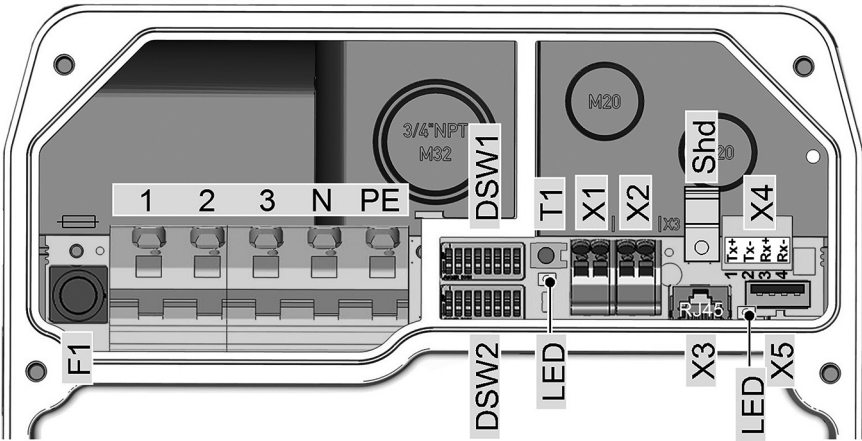

- 1** Mains connection outer conductor 1
- 2** Mains connection outer conductor 2
- 3** Mains connection outer conductor 3
- N** Mains connection, N conductor
- PE** mains connection, PE conductor
- F1** Fuse holder
- DSW1** DIP switch for configuration
- DSW2** DIP switch for addressing

- T1** Service button
- LED** Status LED, internal
- X1** Enable input
- X2** RS485 connector
- X3** Diagnostic connector, RJ45
- X4** Ethernet1 connector, LSA+ terminals
- X5** USB connector
- Shd** Shield connection for Ethernet1 connection terminals



IMPORTANT

The X3 diagnostic connection is suitable only for error analysis and must not be used to connect the device to a network. ◀



Note

The connection overview shows all the options of the device, but the legend only lists the available options. It is possible that your version of the device will not have all the connections available. ◀

Connecting the supply cable

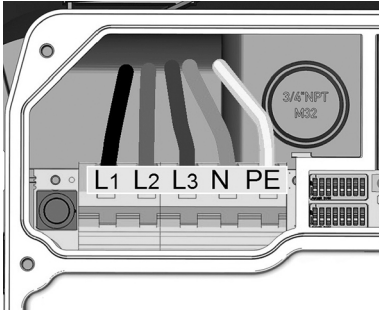

1. Cut the connecting wires to the appropriate length. They should be kept as short as possible.



Note

The PE conductor must be longer than the other conductors. ◀

2. Strip approximately 12 mm of insulation of the connecting wires. We recommend the use of wire-end ferrules for fine connecting wires.
3. Connect the supply cable **L1**, **L2**, **L3**, **N** and **PE**.

1-phase connection

It is also possible to connect the Wallbox on a 1-phase basis. Use terminals **L1**, **N** and **PE** for this purpose.



Note

Make a note of which outer conductor you connect to terminal **L1** if you are installing multiple Wallboxes in a group. ◀

Technical data of the connection terminal

- ▷ Rigid (min.-max.): 0.2 – 16 mm²
- ▷ Flexible (min.-max.): 0.2 – 16 mm²
- ▷ AWG (min.-max.): 24 – 6
- ▷ Flexible (min.-max.) with wire-end ferrule:
without/with plastic sleeve
0.25 – 10/0.25 – 10 mm²
- ▷ Stripping length: 12 mm

Using the supply terminals (spring-type terminal)



IMPORTANT

This terminal is not a clamp-type terminal and must be activated for the connection. If the terminal is not completely opened before the cable is connected, it is possible that the device will function when it is commissioned but is then damaged during the first charging cycle with high current through overheating. ◀



Note

Danger of breaking the terminal.

Do not lever the screwdriver upwards, downwards or to the side. ◀

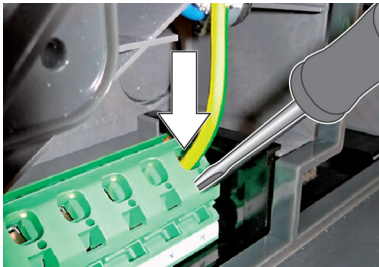
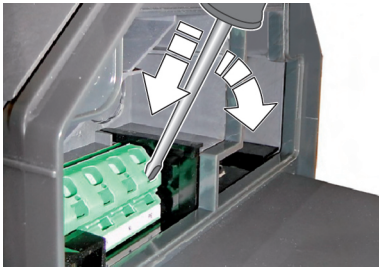
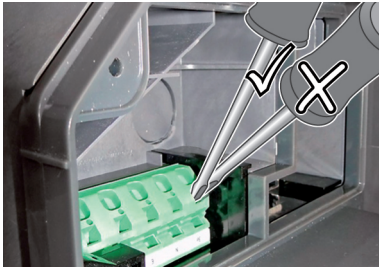

Open the supply terminal

1. Slide a slotted head screwdriver with a width of **5.5 mm**, as shown in the illustration, into the supply terminal.
2. Press the screwdriver into the supply terminal.



Note

As you press the screwdriver into the terminal, its angle will change. ◀

Connect the wire

1. Slide the stripped connecting wire into the supply terminal.



IMPORTANT

If you attempt to slide in the wire when the terminal is not open, there is a risk of fire due to inadequate contact. ◀

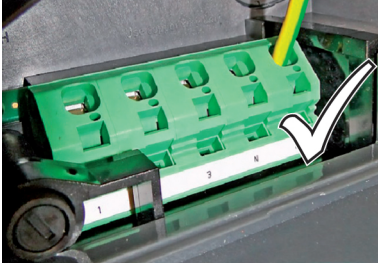

Close the supply terminal

1. Pull the screwdriver fully out of the terminal to close the contact.
2. Check that the connecting wire is secure.
3. Connect the other connecting wires in the same way.

Terminals X1/X2

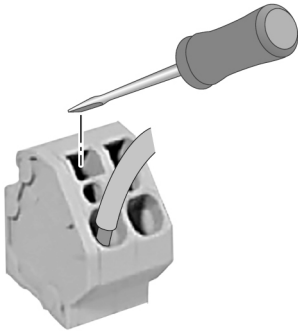

Terminal data for X1/X2

- ▷ Spring-type terminals
- ▷ Cross-section (min.-max.): 0.08 – 4 mm²
- ▷ AWG (min.-max.): 28 – 12
- ▷ Stripping length: 8 mm
- ▷ Slotted screwdriver: 3.0 mm

Enable input X1

The enable input is designed for use with a floating contact. Using the enable input, it is possible to control the Wallbox using external components (for example an external key switch, ripple control receiver from the power supplier, domestic controller, time switch, combination lock, photovoltaic system, etc.).

Circuit diagram:

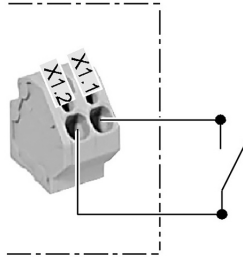

Electrical requirements/Connection:

Safe isolation from dangerous voltages must be ensured outside the device for this control cable.

1. Connect the wires on enable input X1 as shown in the circuit diagram.

Logical function:

Enable contact	Status of Wallbox
Open	DISABLED
Closed	READY

DIP switch setting:

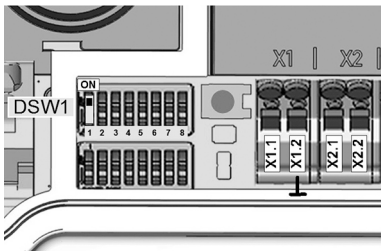

The use of the enable input must be activated by a DIP switch setting.

Use enable input:

- ▷ Yes: DSW1.1 = ON
- ▷ No: DSW1.1 = OFF (default)

RS485 connection X2



Note

A detailed description for using this function is provided in the section entitled [Domestic connection monitoring \(post-meter fuse\)](#). ◀

Schematic diagram

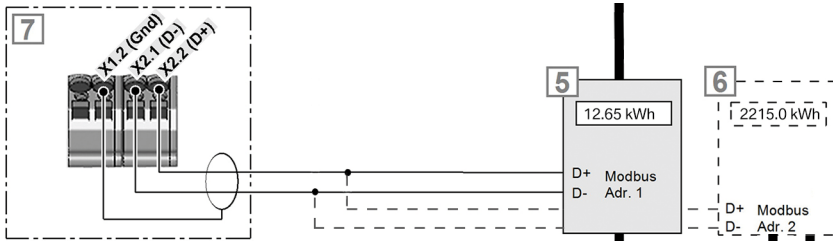

5 Meter 1 (domestic connection meter)

7 Wallbox connection terminal block

6 Meter 2 (optional, photovoltaic meter)

The RS485 connection **X2** is used for communicating with up to two smart electricity meters using the Modbus protocol (for a list of supported types and the corresponding parameters and terminal assignments for the installed meter, see section entitled [Meters with Modbus RTU \(RS485\) interface](#)). In addition to the RS485 data cables on terminal **X2.1** and **X2.2**, there is an earth connection available on terminal **X1.2 (Gnd)** for the cable shield. We recommend that you use a shielded, twisted connection cable (>0.5 mm²).

The cable shield must not be connected to the protective conductor potential (for example, Shd connection) at any other point. The Gnd is to be connected to the meter depending on availability.



Note

Terminal **X1.2 (Gnd)**, the Gnd cable on the RS485 cable or its shield must not be routed on the shield support **Shd** of the Ethernet1 connection **X4**. ◀



Note

Detailed information about the electrical connection of the meter is provided in the installation instructions supplied by the meter manufacturer. ◀

Electrical requirements/Connection









1. Connect the wires on the RS485 connections **X1** and **X2** as shown in the circuit diagram. Safe isolation from dangerous voltages must be ensured outside the device for this control cable.
2. Set the meters used as shown in the table, see [Meters with Modbus RTU \(RS485\) interface](#). Refer to the installation instructions provided by the meter manufacturer for this purpose.

Ethernet1 connection X4

The Ethernet1 connection takes the form of a terminal block in LSA+® form. Permanently wired communication can be enabled using the Ethernet1 connection.

Colour coding

To suit the cabling standard used in the building, the contacts are wired in accordance with **TIA-568A/B** for 100BaseT as follows:

Pin	-568A Pair	-568B Pair	-568A Colour	-568B Colour
1 (Tx+)	3	2	 White/Green line	 White/Orange line
2 (Tx-)	3	2	 Green/White line or green	 Orange/White line or orange
3 (Rx+)	2	3	 White/Orange line	 White/Green line
4 (Rx-)	2	3	 Orange/White line or orange	 Green/White line or green

Terminal data:

Category	Diameter of wire	Diameter of insulation
Rigid cable Cat 5e / Cat 6 STP	0.36 mm (AWG 27)	0.7 – 0.75 mm
	0.4 – 0.64 mm (AWG 26 – AWG 22)	0.7 – 1.4 mm
Cat 6 STP	0.51 – 0.81 mm (AWG 24 – AWG 20)	1.0 – 1.4 mm
Flexible cable Cat 5e / Cat 6 STP	7 x 0.2 mm (AWG 24)	1.1 – 1.4 mm

Recommended tool:

KRONE LSA+ ® insertion tool for connecting the wires without solder, screws or stripping whilst at the same time cutting off the residual length.

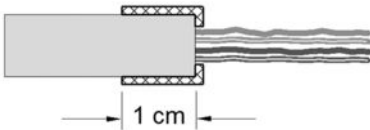

Preparing the connection cable

1. Strip the connection cable approx. 6 cm.
2. Fold back the shield braid approx. 1 cm in full, and wrap it with conductive textile adhesive tape.

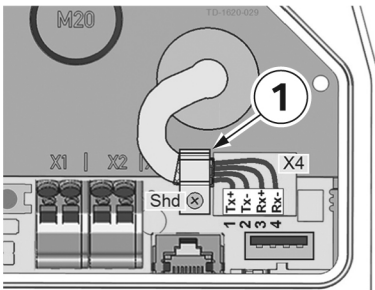

Connecting the cable

1. Using an STP cable, secure the connection cable at the point of the wrapped shield braid in cable clamp **1**.

The cable clamp must be screwed to the shield connection **Shd** on the printed circuit board.

2. Connect the wires to the Ethernet1 terminal block **X4** using the insertion tool.



IMPORTANT

Danger of damage.

Ensure that the connection area is clean so that no dirt, for example wire residues, can get into the interior of the Wallbox. ◀

SETTINGS

DIP switch settings



Note

Changes to the DIP switch settings only become effective after the Wallbox has been restarted! To do so, press **Service button** until the 1st signal tone sounds (about two seconds). Alternatively, you can also switch the supply voltage off and on again. ◀



IMPORTANT

If the **Service button** is pressed for too long (around 5 seconds), the RFID cards may be deleted. ◀



Note

Switches which are not described here must be left in the OFF position. ◀

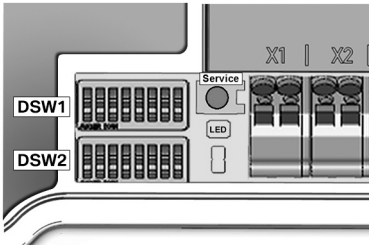

DIP switches

The DIP switches are used to address and configure the Wallbox and are located under the termination panel cover.

DSW1: Configuration, DIP switch upper

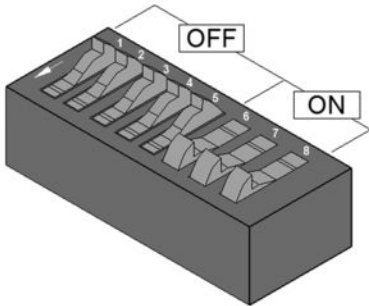

DIP switch specimen illustration

The illustration shows the position of the DIP switches for ON and OFF states to make the process easier to explain.



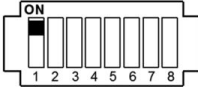
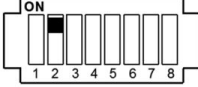
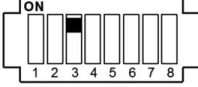

Control functions

Function	DIP switch		Illustration
External enable input [X1] is used.	DSW1.1	ON = yes	 <p>The diagram shows a horizontal row of eight DIP switches labeled 1 through 8. The first switch (1) is in the 'ON' position, indicated by a black rectangle on its top half. The other seven switches (2-8) are in the 'OFF' position, with no black rectangle. The word 'ON' is printed above the first switch.</p>
Domestic connection monitoring is used (RS485 connection [X2] with Modbus functionality).	DSW1.2	ON = yes	 <p>The diagram shows a horizontal row of eight DIP switches labeled 1 through 8. The second switch (2) is in the 'ON' position, indicated by a black rectangle on its top half. The other seven switches (1, 3-8) are in the 'OFF' position. The word 'ON' is printed above the second switch.</p>
Activate SmartHome and app interface via UDP. ⁽¹⁾	DSW1.3	ON = yes	 <p>The diagram shows a horizontal row of eight DIP switches labeled 1 through 8. The third switch (3) is in the 'ON' position, indicated by a black rectangle on its top half. The other seven switches (1, 2, 4-8) are in the 'OFF' position. The word 'ON' is printed above the third switch.</p>

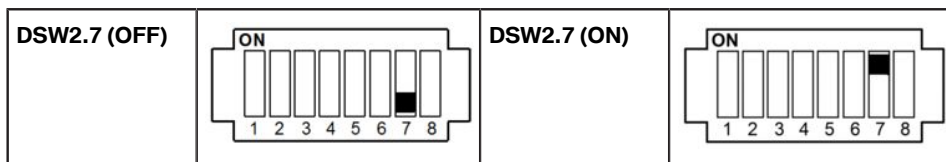
⁽¹⁾ Access only using secure networks, in order to prevent the Wallbox being manipulated by third parties.



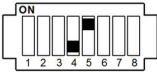
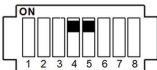
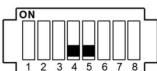
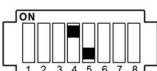

Post-meter fuse on the domestic installation (DSW1 and DSW 2)

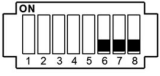

Current value	DIP switch			Figure (DSW1)
	DSW2.7	DSW1.4	DSW1.5	
25 A	OFF	OFF	OFF	
35 A	OFF	ON	OFF	
50 A	OFF	OFF	ON	
63 A	OFF	ON	ON	
80 A	ON	OFF	OFF	
100 A	ON	ON	OFF	
125 A	ON	OFF	ON	
150 A	ON	ON	ON	

Maximum charge current (DSW1)

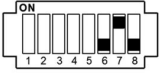
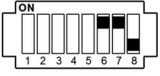
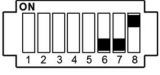
The following DIP switches can be used to set a maximum value for the charge current. This maximum value is valid for each connected phase individually and not as a total value for all phases together. The power input is transmitted to the vehicle (Control Pilot Duty Cycle). A maximum value can only be set which is less than or equal to the operating current according to the rating plate.

Current	DIP switch			Illustration
	DSW1.6	DSW1.7	DSW1.8	
	ON	ON	ON	
10 A	OFF	OFF	OFF	
13 A	ON	OFF	OFF	
16 A	OFF	ON	OFF	
20 A	ON	ON	OFF	
25 A	OFF	OFF	ON	
32 A	ON	OFF	ON	

IP address

OBTAIN IP ADDRESS THROUGH DHCP (NO ADDRESSING) DSW2.1 to DSW2.4=OFF/DSW2.6=OFF

The Wallbox attempts to obtain an IP address through a **DHCP** server. This is also the default setting for a Wallbox without a network connection.

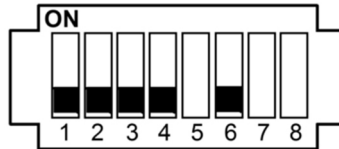

USE PERMANENT IP ADDRESS DSW2.1 to DSW2.4/DSW2.6=ON

The addressing process is completed using DIP switches **DSW2.1** to **DSW2.4**. The configurable Ethernet addresses start at **10 + DIP switch setting**.

Addresses 11 to 25 can be used
[192.168.25.xx] with 4-bit addressing. Subnet mask: [255.255.255.0]

DSW2.1 = Address bit 2^0 (value=1)

DSW2.2 = Address bit 2^1 (value=2)

DSW2.3 = Address bit 2^2 (value=4)

DSW2.4 = Address bit 2^3 (value=8)

Note: Function is possible only with BMW Wallbox and BMW Wallbox Plus.



Example for address "17":

DSW2.1 = ON (value=1)

DSW2.2 = ON (value=2)

DSW2.3 = ON (value=4)

DSW2.4 = OFF (value=0)

Address = **10** + 1 + 2 + 4 + 0 = **17**

Commissioning mode (DSW2.8)

Activate commissioning mode, see section entitled [Commissioning mode/Self-test](#).

DSW2.8

ON = yes

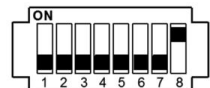

COMMISSIONING

General commissioning procedure

- ▷ Clean the connection zone (remove material residues and dirt).
- ▷ Before commissioning the device check that all screw and terminal connections are tight.
- ▷ Switch on the supply voltage. After the self-test, the status LED (LED bar) must light up blue after 15-20 seconds.
- ▷ Conduct the specified initial tests to comply with local regulations and laws.
- ▷ Close the Wallbox terminal panel cover if it has been opened. See section entitled [Installing the termination panel cover](#).
- ▷ Install the housing cover, see section entitled [Installing the housing cover](#).

Commissioning mode/Self-test

The Wallbox can be set to a commissioning mode to help with the initial system tests. This conducts a self-test on the device (interlock, contactor actuation, current measurement, etc.) and any errors are displayed.

After the test has been successfully completed without a vehicle connected, the contactor will be actuated for a limited period of time (around 10 minutes) to allow the initial tests to be completed. A normal charging cycle is not possible in commissioning mode.

The lock on the charging socket is activated to prevent a connection (Wallbox versions with a charging socket only).

If the Wallbox is switched on in commissioning mode using the supply voltage, an error (white-red-red-red) will be displayed for safety reasons to prevent accidental activation.

Enabling the commissioning mode

1. Set DIP switch **DSW2.8** to **ON**.
2. Reset the Wallbox. To do this, press the **Service button** for **1 second** (signal tone). Commissioning mode is now enabled and is indicated by the status LED being lit in orange.
3. It is now possible for approximately 10 minutes to contact with the measuring instrument using standard test clips (for example Astaco® test clips from BEHA) and conduct the required safety tests. After this time the contactor is disabled and the Wallbox switched off.

Disabling the commissioning mode

1. Set DIP switch **DSW2.8** to **OFF** again.
2. Conduct a reset of the Wallbox. Press the **Service button** for **1 second** (signal tone) for this purpose or switch the supply voltage off and on again. The Wallbox will power up in operating mode and is then ready for use.

Safety tests

Before using the device for the first time, check the effectiveness of the system's protective measure(s) according to national regulations such as ÖVE/ÖNORM E8001-6-61, DIN VDE 0100-600.

Electrical systems or devices must be tested by the installer of the system or device before being used for the first time. This also applies to the extension or modification of existing systems or electrical devices. However, we must expressly point out that all regulations for the protective measures must be observed.

Among others, the following points must be taken into account:

1. The tests: The continuity of the connections of the protective conductor, insulation resistance, residual-current-operated circuit breaker, trip current and trip time must be found for the extended or modified part.
2. The measuring instruments used must comply with national regulations, for example DIN EN 60557 (VDE 0413) "Electrical safety in low voltage networks up to AC 1000 V and DC 1500 V".
3. The measurement results must be documented. A test log for the test must be prepared and archived.

RFID authorisation

The supplied RFID cards are pre-programmed at the factory for all Wallboxes, which means that the function of the Wallbox Plus is active.

To disable the RFID function or program additional cards, please refer to the programming instructions in the operating manual.

Installing the terminal cover

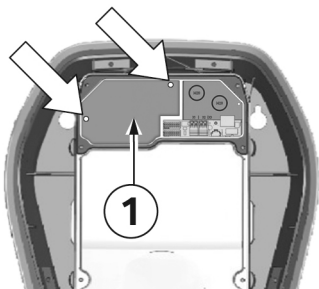

Fastening screws

1. Install the terminal cover **1** again using the two fastening screws if they have been removed.

Installing the termination panel cover



Note

Confirm that an up-to-date version of the software is available before you install the terminal panel cover. For further information see section entitled [SOFTWARE UPDATE](#). ◀



Note

The Wallbox must not be permanently commissioned if this cover is missing or damaged. Alternative covers must not be used. ◀

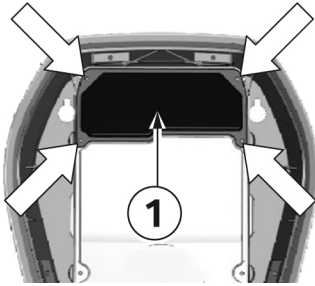

Fastening screws

1. Insert the termination panel cover **1** again.
2. Install the termination panel cover again using the four screws.

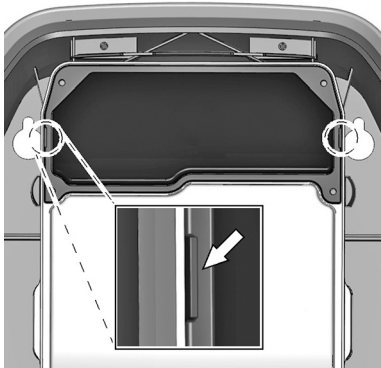

Housing marking

1. Tighten the four screws until the housing markings on the right and left on the termination panel cover are flush with the housing.
2. The termination panel cover must correctly seal the housing.

Increased force is required for the self-tapping screws: 3.5 Nm.

Installing the housing cover



Note

This cover is not relevant for the safe operation of the Wallbox. ◀

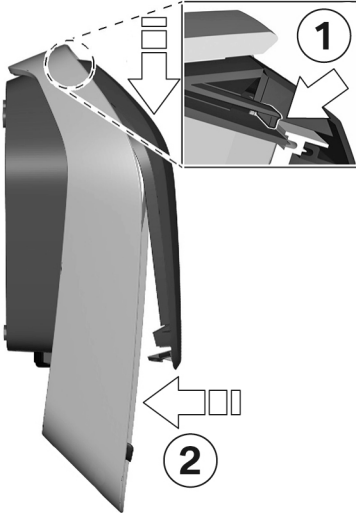

Attach the housing cover

1. Attach the housing cover at the top and ensure that the hooks on the housing cover are correctly attached **1**.
2. Press the cover downwards and then swing the housing cover **2** backwards.
The housing cover must slide into the bottom guides without any major resistance.



IMPORTANT

Ensure that the housing cover is correctly positioned in the housing guide on all sides. There must only be a minimum uniform gap. ◀

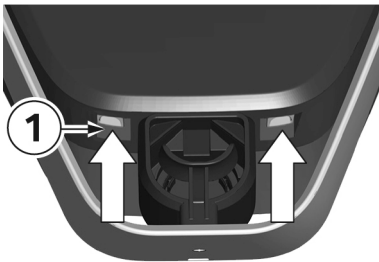

Interlocks

1. Press the bottom section of the housing cover on to the Wallbox until the interlocks **1** fully engage.

MISCELLANEOUS

Dimensions

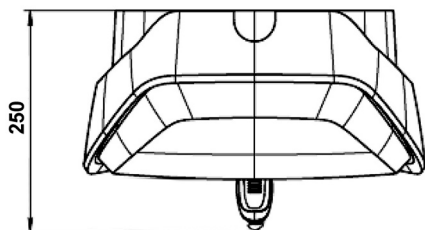
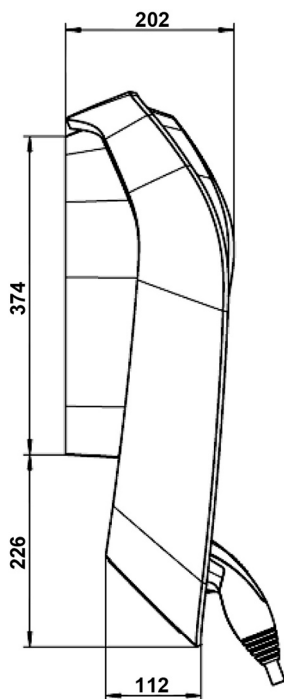
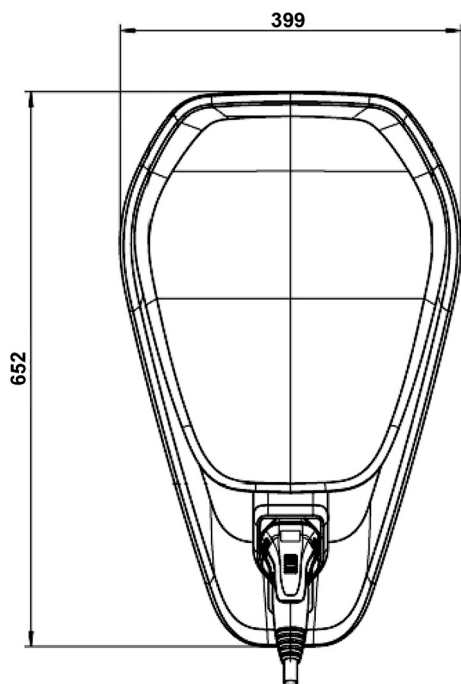

Dimensions in millimetres

Technical data

Electrical data	
Charging mode:	Mode 3 as per IEC 61851-1
Cable feed:	Surface-mounted or flush-mounted
Connection cross-section:	Minimum cross-section (depending on the cable and routing method): - 5 x 2.5 mm ² (16 A rated current) - 5 x 6.0 mm ² (32 A rated current)
Supply terminals:	Connection cable: - Rigid (min.-max.): 0.2 – 16 mm ² - Flexible (min.-max.): 0.2 – 16 mm ² - AWG (min.-max.): 24 – 6 - Flexible (min.-max.) with wire-end ferrule without/with plastic sleeve: 0.25 – 10/0.25 – 10 mm ²
Temperature rating of supply terminals:	105 °C
Rated current (configurable connection values):	10 A, 13 A, 16 A, 20 A, 25 A, or 32 A 3-phase or 1-phase
Mains voltage:	220-240 V ~ 220/380 - 240/415 V 3N~
Mains frequency:	50 Hz/60 Hz
Mains configuration:	TT/TN/IT
Overvoltage category:	III as per EN 60664
Rated short-time current resistance:	< 10 kA effective value to EN 61439-1
Fuse (in the domestic installation):	The fusing must comply with the local regulations depending on the socket/cable version (see rating plate).
DC residual current monitoring:	≤ 6 mA DC (integral)
Ventilation during charging:	Not supported

Electrical data	
Version with charging socket:	Type 2 standard socket with shutter: 32 A/400 VAC to EN 62196-1 and EN 62196-2
Version with charging cable: (see model plate for rating)	Type 2 cable: up to 32 A/400 VAC to EN 62196-1 and EN 62196-2
Protection class:	I
Device's IP protection class:	IP54
Protection against mechanical impact:	IK08

Interfaces	
Enable input [X1]:	Enable input for external authorisation: Connection cable: - Cross-section (min.-max.): 0.08 – 4 mm ² - AWG (min.-max.): 28 – 12
RS485 connection [X2]:	Extra-low safety voltage <50 V Connection cable: - Cross-section (min.-max.): 0.08 – 4 mm ² - AWG (min.-max.): 28 – 12
Diagnostic connection [X3]:	RJ45
Ethernet1 connection [X4]:	LSA+ terminals
USB connection [X5]:	USB jack type A (max. 500 mA)
RFID (optional):	MIFARE cards or tags to ISO 14443 or ISO 15693 Tag-It or Tag-It cards or tags to ISO 15693

Mechanical data	
Dimensions (W x H x D):	399 x 652 x 202 mm (without plug)
Weight:	approx. 10 kg (depending on version)
Assembly (stationary):	On the wall or on the column

Ambient conditions	
Use:	Indoor and outdoor use
Operating temperature at 16 A:	-25 °C to +50 °C No direct sunshine
Operating temperature at 32 A:	-25 °C to +40 °C No direct sunshine
Temperature properties:	<p>This is not a safety device, it is just an operating function. The specified operating temperature range must not be exceeded.</p> <p>The device supplies the charging current continuously at the specified operating temperature ranges.</p> <p>In order to increase the charging availability, the charging current level is reduced to 16 A if the temperature is exceeded. The charging cycle may subsequently also be shut down. The charging cycle is continued, and the charging current value is increased again after cooling.</p>
Storage temperature range:	-30 °C to +80 °C (-22 °F to 176 °F)
Temperature change rate:	max. 0.5 °C/min (max. 32.9°F/min)
Maximum relative humidity:	5 % to 95 %, non-condensing
Altitude:	max. 2000 m above sea level

MAINTENANCE

Replacing the fuse

Fuse	Current/Voltage	Types	Dimensions
F1	6.3 A / 250 V	Slow-action with high shut-down capacity (>1500 A) (T) (H)	5 x 20 mm fuse



WARNING

Electrical danger.

The terminal cover may only be opened by authorised electricians with the appropriate training and qualifications. ◀



ESD

Danger of damage. Electronic components may be destroyed if touched.

Before handling modules, perform an electrical discharge process by touching a metallic earthed object. ◀

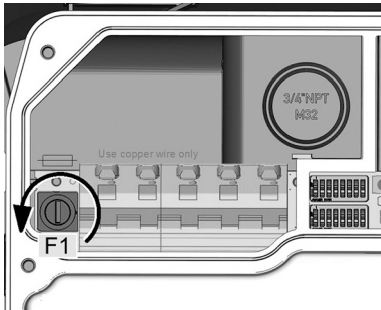

Replace fuse

1. Switch off the supply cable to the Wallbox completely.
2. Remove the housing cover, see section entitled [Removing the housing cover](#).
3. Remove the terminal panel cover and terminal cover, see sections entitled [Removing the termination panel cover](#) and [Removing the terminal cover](#).
4. Press a screwdriver into the opening of the fuse holder.
5. Turn the fuse holder anti-clockwise until it automatically jumps forward due to the spring.
6. Replace the fuse.
7. Press the fuse holder into place and secure it again by turning it clockwise.
8. Assemble the device again following the instructions above in reverse order.

DISPOSAL



After proper decommissioning of the device, please have the device disposed of by service or dispose of it in compliance with all currently valid disposal regulations.



Disposal information

The symbol of the waste bin with a line through it indicates that electrical and electronic devices including accessories must be disposed of separately from general household waste. There are instructions on the product, in the instructions for use or on the packaging.

The materials can be recycled as shown by their labelling. You can make a significant contribution to protecting our environment by reusing, recycling the material or other forms of recycling of end-of-life devices.

SOFTWARE UPDATE

The software can be updated using this web interface. Further information can be found in the “Configuration” section of the operating manual.

The software can also be updated using the USB connection inside the device. Detailed instructions for the recommended procedure can be found on the BMW Service page for charging products (<https://charging.bmwgroup.com/web/wbdoc/>).

The software for the Wallbox can also be updated using the USB connector inside the device. The housing cover and the terminal panel cover must be removed to gain access to the USB connector.

Follow the instructions in the manual for performing software updates.



The latest **software** and the associated instructions can be downloaded from the internet at <https://charging.bmwgroup.com/web/wbdoc/>. A new software version may, for example, take account of changed standards or improve compatibility with new electric or plug-in hybrid vehicles.

PRODUCT INFORMATION PAGE



This telecommunications equipment complies with the NTC requirement.

INDEX

A

About this manual.....	12
------------------------	----

B

BMW Wallbox Plus overview.....	14
--------------------------------	----

C

Cable inlet from above.....	28
Cable inlet from the rear.....	29
Charging socket.....	15
Circuit breaker.....	18
Commissioning.....	48
Commissioning mode / Self-test.....	48
Connection diagram with open termination panel cover.....	35
Connect the supply cable.....	36

D

DIP switch settings.....	43
Disposal.....	58

E

Enable input [X1].....	39
Ethernet1 connection X4.....	41

F

Fuse.....	57
-----------	----

G

General criteria for selecting an installation site.....	16
--	----

I

Inserting additional cables.....	33
Insert the supply cable.....	33
Installation.....	13, 23
Installation requirements.....	23
Install the housing cover.....	52
Install the terminal cover.....	50
Install the termination panel cover.....	51
Install the Wallbox.....	31
Intended use.....	12

L

Legal information.....	7
------------------------	---

M

Mains isolation device.....	18
Modbus.....	40

P

Package.....	13
Prepare cable inlet.....	30
Program RFID cards.....	49

R

Recommended installation positions.....	24
Remove the housing cover.....	26
Remove the terminal cover.....	28
Remove the termination panel cover.....	27
Required distance.....	25
Residual-current-operated circuit breaker.....	18
RS485.....	40

S

Safety instructions.....	10
Safety tests.....	49
Secure the Wallbox.....	34
Supply cable.....	18

T

Technical data.....	54
Tool list.....	23

U

Use of the supply terminals.....	37
----------------------------------	----

EU Declaration of Conformity

We declare that the following product(s)

Name of product	Wallbox Plus 22kW T2
BMW part number	61 90 2420905
Model / Type Ref.	BMW-10-EC240522-E1R
Type of product	Electric vehicle conductive charging system

Name of product	Wallbox Plus 22kW T2S
BMW part number	61 90 2420913
Model / Type Ref.	BMW-10-ESS40022-E1R
Type of product	Electric vehicle conductive charging system

Name of product	Wallbox Plus 22kW T2S
BMW part number	61 90 272423
Model / Type Ref.	MIN-10-ESS40022-E1R
Type of product	Electric vehicle conductive charging system

Name of product	Wallbox Connect 22kW T2
BMW part number	61 90 2420912
Model / Type Ref.	BMW-10-EC2405B2-E1R
Type of product	Electric vehicle conductive charging system

Company
Bayerische
Motoren Werke
Aktiengesellschaft

Issuing department
CP-152
Product Management
Accessories
Electric, consumer
electronics & eMobility

Postal address
BMW AG
80788 München

Office address
Frankfurter Ring 7-9
80807 München

Telephone
Switchboard
+49 89 382-0

Fax
+49 89 382-25858

Internet
www.bmwgroup.com

Bank details
Deutsche Bank
IBAN DE05 7007 0010
0152 6946 00
BIC DEUTDE33

**Chairman of the
Supervisory Board**
Norbert Reithofer

Board of Management
Harald Krüger,
Chairman
Milagros Caiña Carreiro-
Andree
Klaus Fröhlich
Pieter Nota
Nicolas Peter
Ian Peter
Schwarzenbauer
Andreas Wendt
Oliver Zipse

**Registered in
Germany**
München HRB 42243

is/are in conformity with the following European Council Directive(s):

- **EU-Directive 2014/53/EU**
- **EU-Directive 2011/65/EU**

Conformity to the directive 2014/53/EU is assured by the compliance with the applicable parts of the following harmonized European standards:

- **EN 300 330 V2.1.1**
- **EN 300 328 V2.1.1 (1)**

Conformity to the directive 2011/65/EU is assured by the compliance with the applicable parts of the following harmonized European standards:

- **EN 50581:2012**

The conformity to the directive 2014/53/EU is not impaired by the removal or the installation of the BMW communications module (WLAN/WiFi functionality). The BMW communications module itself is also in conformity with 2014/53/EU. Conformity to the essential requirements defined in Art. 3 No. 1 Lit. (b) 2014/53/EU concerning 2014/30/EU is assured by the compliance with the applicable parts of the following harmonized European standards:

- **EN 61000-6-2:2005**
- **EN 61000-6-3:2007 + A1:2011**
- **EN 61000-3-11:2000**
- **EN 61000-3-12:2011**
- **EN 301 489-1 V1.9.2**

Conformity to the essential requirements defined in Art. 3 No. 1 Lit (a) 2014/53/EU concerning 2014/35/EU is assured by the compliance with the applicable parts of the following harmonized European standards:

- **EN 61851-1:2011**
- **EN 61851-22:2002**
- **EN 61439-1:2011**
- **EN 50364:2010**
- **EN 62479:2010 ⁽¹⁾**

The assessment and testing concerning human exposition was performed according to the following requirements:

- **Council Recommendation of 12 July 1999 on the limitation of exposure of the general public to electromagnetic fields (0 Hz to 300 GHz) 1999/519/EC**

The following operating parameters are specified for the RFID module of the device:

- **Frequency: 13,553 – 13,567 MHz**
- **EIRP: 0,200 μ W**

The following operating parameters are specified for the WLAN/WiFi module of the device:

- **Frequency: 2400 – 2483,5 MHz ⁽¹⁾**
- **EIRP: 100 mW ⁽¹⁾**

Important notes:

Any modification on the product(s) that is performed without the consent of BMW will render this declaration invalid. This declaration certifies the conformity with the directives mentioned, but does not imply any warranty of the features of the product(s). The safety instructions contained in the documentation supplied with the product(s) must be followed.

This declaration of conformity is issued under the sole responsibility of the manufacturer.

⁽¹⁾ Only applicable if the BMW communication module is installed.

München, 11.04.2019

Place, Date

A handwritten signature in blue ink is located above the name.

Michael Fischmann
CP-152, Product Management Accessories

Mehr über BMW

www.bmw.de
www.bmw.com



Freude am Fahren



Doc #100649 - Mat #112031